

2021  
2022  
COLLECTIONS



CREATE  
YOUR  
HOME

MADE IN ITALY



Digital catalogue

# Design-Manufaktur – Made in Italy



## MUNARI SINCE 1977

*Italien:*  
*Mutterland für Design und schöne Formen*  
*MUNARI - Made in Italy (Verona)*

*Edles Ambiente* für ein traumhaftes Zuhause -  
MUNARI steht seit 43 Jahren für edle Einrichtungs-  
ideen und modernen Lifestyle.

Unter dem Motto "Create Your Home" entführen  
wir Sie in die Welt des Wohnens und bieten  
Ihnen Einrichtungsideen für alle Wohnbereiche.  
*Ob Industrieloft, Stadtwohnung oder Einfamilienhaus,*  
das zeitlose Design passt sich allen Lebensräumen an.

Moderne Formen, edle Details und außergewöhnliche  
Materialkombinationen sorgen für eine perfekte  
Inszenierung und eine stimmungsvolle Atmosphäre  
Ihres Wohnraums.

Mit Munari können Sie durch die Einflüsse von  
Licht und Schatten, Glas in vielen Formen und  
Ausführungen immer wieder neu erleben. Ob in  
komplett Glas oder in Absetzung mit Echtholz oder  
Keramik Sie erhalten immer ein Markenmöbel mit  
unverwechselbarem Charakter.

Lassen Sie sich von unseren Ideen und Kollektionen  
faszinieren!

## QUALITÄT & DESIGN MIT VIEL HANDARBEIT



# CREATE YOUR HOME

MODENA

Seite 08 - 15



TV Möbel - Groundstyle



TV Möbel - Footstyle

MODENA

Seite 16 - 19



Wohnmöbel - Groundstyle



Wohnmöbel - Wallstyle

MODENA

Seite 20 - 21



Beimöbel - Freestyle



Garderobe - Entrestyle

# Kollektion 2020

MO&MA

Seite 30 - 35



TV Möbel - Groundstyle



TV Möbel - Footstyle

MO&MA

Seite 36 - 37



TV Möbel - Wallstyle



Beimöbel - Freestyle

RAVENNA

Seite 40 - 45



TV Möbel - Groundstyle



TV Möbel - Footstyle

# KOLLEKTION MODENA

Design by Eros Angelini

## Zeitlos elegant und technisch voll im Trend

Für ein einzigartiges Zuhause werden in der MODENA Kollektion exklusives Design mit ausgewählten Materialien und raffinierter Technik zu besonderen Möbeln vereint. Das entwickelte Planungssystem definiert eine individuelle Raumgestaltung in den Bereichen Wohnzimmer, Apartment und Speisezimmer und erlaubt eine umfangreiche Produktgestaltung mit verschiedenen Materialkombinationen (Glas, Echtholz, Keramik und Metall).

Mit seinem besonderen Licht-Designmerkmal in der Glasfront setzt sich das Programm Modena von allen herkömmlichen Wohnmöbeln deutlich ab und glänzt zusätzlich zum temperierten Glas durch viele technische Extras, die bereits in den Möbeln enthalten sind (infrarotdurchlässige Front, LED-Bel., Technikfach, Mehrfachsteckdose, uvm.).

Zeitlose Designmöbel, die Sie Ihr Leben lang begleiten und immer Ihrer Zeit voraus bleiben.



LIGHTING UP  
YOUR  
HOME



## MODENA KOLLEKTION



Create your Home - TV-Elemente / Apartment

## CREATE YOUR HOME



Create your Home - Esszimmer / Dining



Create your Home - Wohnen / Living



Create your Home - Einzeilmöbel / Solitär



Create your Home - Garderoben / Entree'

# MODENA KOLLEKTION IM DETAIL



TV-Element MO 275 BI + TV-Säule MI 310 / SP62



Sound-System ACS 120 W



TV-Element MO 150 BI + TV Säule AC 380 AN

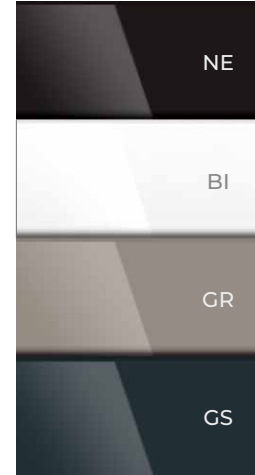

- NE Glas schwarz glänzend
- BI Glas weiß glänzend
- GR Glas grau glänzend
- GS Glas dunkelgrau glänzend



- RA Eiche anthrazit furniert
- RN Asteiche furniert
- NS Nussbaum furniert
- CCE Keramik (Zement)
- CPA Keramik (Stone)

Extras, die je nach Modell bereits in den Möbeln enthalten sind:



Temperiertes Glas



Infrarotdurchlässige Glasfront



LED-Beleuchtung



Technikfach mit Mehrfach-Steckdose



Glas-Einlegeböden



Hochwertige Beschläge



Rückwand Belüftung



Rollen in Sockelplatte

## MODENA TV-ELEMENTE

### MODENA GROUNDSTYLE-SYSTEM

5 Grundbreiten und Endlosplanung im 25er Raster - Breiten 100 / 125 / 150 / 175 / 200cm...Endlos im 25cm Raster  
 2 Systemhöhen - Höhen 42 und 54cm / 1 Systemtiefe - Tiefe 50cm  
 Abdeckplatten in Glas und Echtholz ab 100cm im 25er Raster - max. 300cm

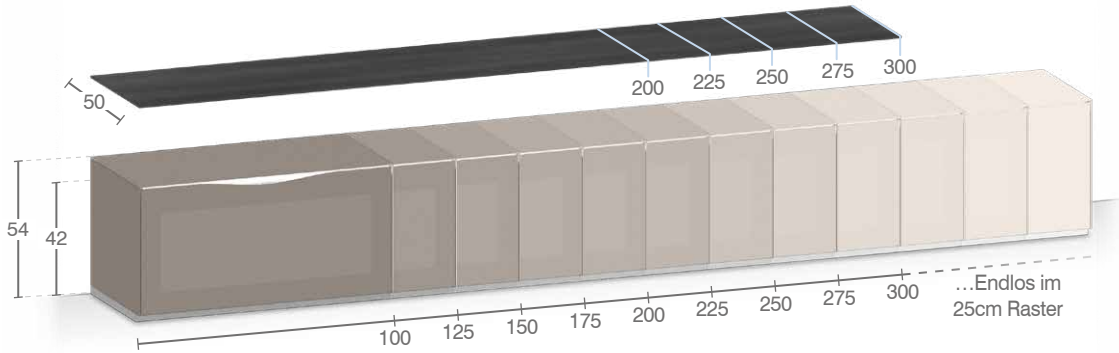

### MODENA WALLSTYLE-SYSTEM

4 Grundbreiten und Endlosplanung im 25er Raster - Breiten 100 / 125 / 150 / 199cm...Endlos im 25cm Raster  
 1 Systemhöhe - Höhen 37cm / 1 Systemtiefe - Tiefe 30cm  
 Abdeckplatten in Echtholz furniert ab 100cm im 25er Raster - max. 300cm

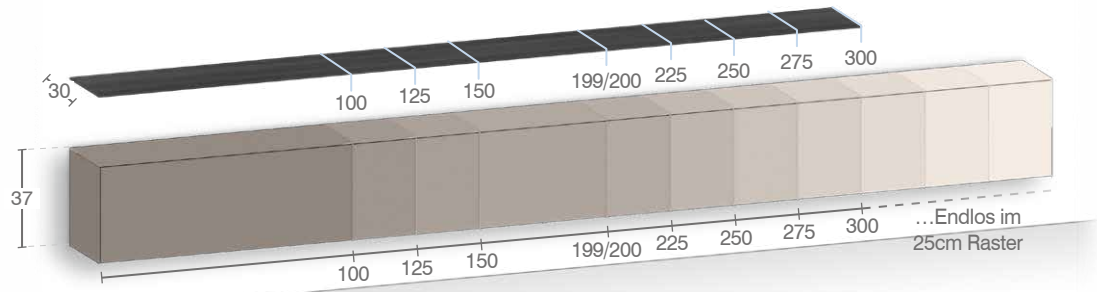

## GROUNDSTYLE



TV-Element MO 106 BI + MOT 100 RN

Breite 100cm



TV-Element MO 112 NE

Breite 125cm

## MODENA TV-ELEMENTE



TV-Element MO 150 GR + MOT 150 RA + MOF 150

Breite 150cm



Sekretär VR 275 GS / TV-Element MO 2200 GS + MOT 200 RN

Breite 75 / 200cm

## GROUNDSTYLE



TV-Element MO 278 BI

Breite 175cm





## DESIGN & SOUND



### SOUNDSYSTEM ACS 120 W B.95 H.18 T.30

Leistung: 120W RMS  
Eingänge: HDMI, Bluetooth,  
Coaxial, Aux TV, Optical  
Equalizer-Modi: live, rock,  
classic, simulate, disco,  
matrin  
Stromversorgung:  
110/220/240 Volt



Hochwertige Lautsprecher



Fernbedienung



Doppelter Subwoofer



Anschlüsse / Eingänge



Digital-Display

## TV-SÄULEN

TV-Säule MI 310 / SP 62 - Edelstahl gebürstet

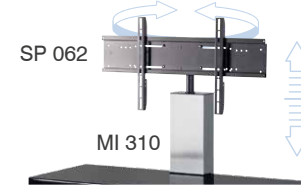

TV-Säule FI 096 - Edelstahl gebürstet



TV-Säulen AC 376

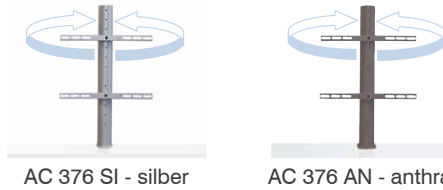

NEW

TV-Säule AC 380 AN



## MODENA WOHNEN



Wohnkombination MO 3A 300 BI-RN + MOT 300 RN

Highboard MO 1120 BI-RN

## LIVING GROUNDSTYLE



Wohnkombination MO 1A 300 BI-RN + MOT 300 RN



Wohnkombination MO 4C 300 GS + 2x MOT 150 CPA

Sideboard MO1222 GS + MOT 220 CPA + MOF 220



Sideboard MO 1187 NE-NS + MOT 185 NS

Wohnkombination MO 5F 300 NE-NS + MOT 300 NS

## MODENA WOHNEN



Wohnkombination MO 7A 325 GR-RA

Breite 325cm

## LIVING - WALLSTYLE



Wohnkombination MO 6A 325 GS-RN + MOT 275 RN

Breite 325cm



Wohnkombination - Planung BI-RA

Breite 250cm



Hängesideboard-Kombination GS-RN Breite 160cm



Hängevitriren-Kombination GS-RN Breite 150cm

## MODENA WOHNEN



Sideboard MO 1223 BI

Breite 220cm

## LIVING - FREESTYLE



Highboard MO 1120 GR-RA + MOT 122

Breite 122cm



Vitrine VR 1123 GS-RN

Breite 122cm



Sekretär VR 275 BI

Breite 75cm



Sideboard MO 1222 NE + MOT 220 RN + MOF 220

Breite 220cm



Couchtisch VR 417 GR

Breite 75cm



Couchtisch MO 114 GS

Breite 120cm

# MODENA ENTREÉ

Design by Eros Angelini & Stephan König

## ERFRISCHEND, ANDERS UND BELEBEND

Erleben Sie ein neues Heimkommen, denn die Zeiten trister und langweiliger Dielen und Garderoben sind passé.

Wohnkultur und individuelles Einrichten auf höchstem Niveau! Bei der Kollektion Modena Entree wird der Eingangsbereich als Präsentation und Spiegelbild des gesamten Wohnraums definiert und nicht nur als Problemlöser für den Dielenbereich gesehen.

Hier werden bereits im Entreebereich Akzente durch ein von klaren Linien geprägtes Design in Kombination mit hoher Funktionalität gesetzt.

Lassen Sie den Alltag vor der Tür und genießen Sie Ihr Zuhause.



HOME  
SWEET  
HOME



## MODENA GARDEROBEN



Kombi.: MOE 1C 150 BI-RN + MOE-TS 150 RN / 2x Paneel MOE 301 RN

Breite 150cm + Paneele

## ENTREÉ-STYLE



Kombi.: MOE 5A 200 GR-RA / je 1 x Paneel MOE 301 / 302 RA

Breite 200cm + Paneele



Kombi.: MOE 3C 150 GS-RN + MOE-TS 150 RN / Paneel MOE 312 GS-RN re.

Breite 225cm



Nach unten öffnend



Nach oben öffnend



Kombi.: MOE 1B 199 NE-SP / je 1x Paneel MOE 301 / 302 NEM

Breite 199cm + Paneele

## MODENA GARDEROBEN



Kombi. Freestyle: Garderobenschrank, Bank, Paneel, Schuhschrank und Spiegel

Breite 250cm

Modular, funktional und elegant, für jede Raumsituation eine perfekte Lösung!

## ENTREÉ-STYLE



Kombi.: MOE 4A 150 BI-RA + MOE-TS 150 RA / Paneel MOE 306 BI-NEL

Breite 225cm

Zuhause: Ein gutes Gefühl wenn ´s passt!



Garderobenschrank  
MOE 327 GR

Garderobenschrank  
MOE 327 NE-SP

Schuhschrank  
MOE 321 GS

Schuhschrank  
MOE 322 NE

Garderobenbank  
MOE 325 / MOE 326

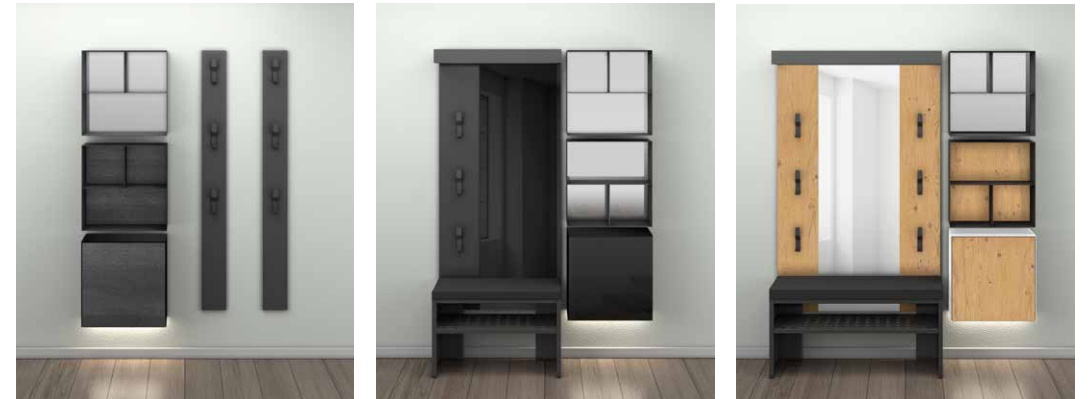

Kleine Kombinationen mit großer Wirkung

# KOLLEKTION MO&MA

Design by Eros Angelini

## Die etwas andere Art des Wohnens

Klare Linien, schnörkellose Eleganz sind Ausdruck von Geschmack und hohem Anspruch.

Design und Technik verschmelzen bei dem Programm MO&MA und bilden eine Harmonie wie bei einem modernen Kunstwerk. Die neue asymmetrische Formsprache setzt, in Kombination mit verschiedenen Materialinnovationen, neue Maßstäbe für den anspruchsvollen Wohnbereich. Hierbei werden Eleganz und Funktionalität in gleichem Maße ohne Kompromisse umgesetzt. Ganz nach dem Munari-Motto "Create Your Home" können die verschiedenen Werkstoffe (Glas / Holz / Keramik / Metall) kombiniert und so das besondere und smarte Möbelstück kreiert werden.

Bei dem Programm MO&MA handelt es sich um ein Lifestyleprodukt der neuesten Generation, das bereits viele technische Extras enthält.



THE ART  
OF  
STYLE





# MO&MA KOLLEKTION IM DETAIL



TV-Element MMB 174 BI-BI-LNO re.

Breite 175cm

Extras, die je nach Modell bereits in den Möbeln enthalten sind:



Temperiertes Glas



Infrarotdurchlässige Glasfront



LED-Beleuchtung

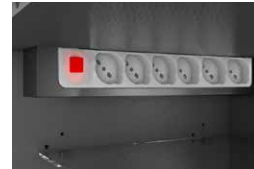

Mehrfach-Steckdose

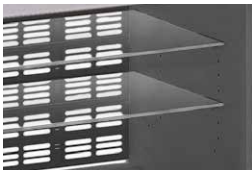

Glas-Einlegeböden



Hochwertige Beschläge



Rückwand-Belüftung

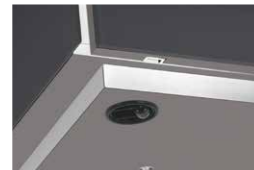

Rollen in Sockelplatte

# MO&MA SYSTEM & MATERIALAUSFÜHRUNGEN

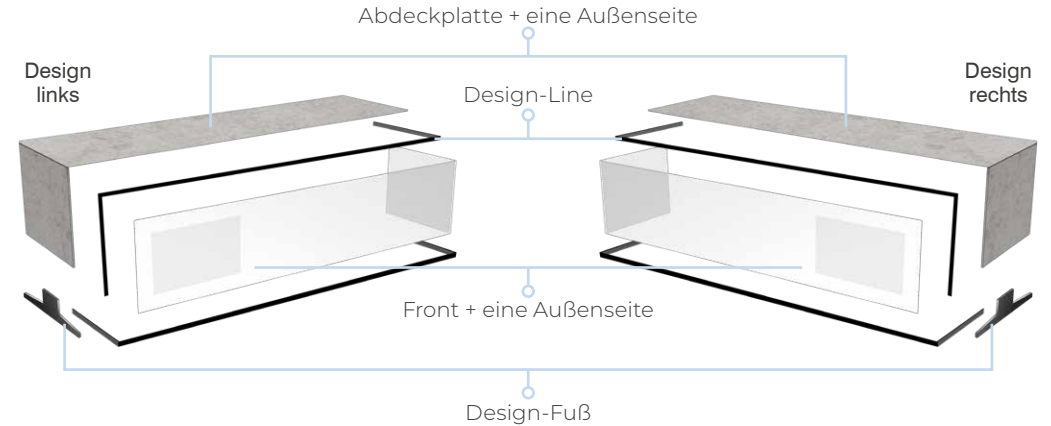

Front + eine Außenseite

Glas



Abdeckplatte + eine Außenseite

Glas



Holz furniert



Keramik



Design-Line

Metall-Optik

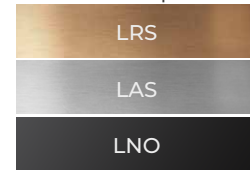

Design-Fuß

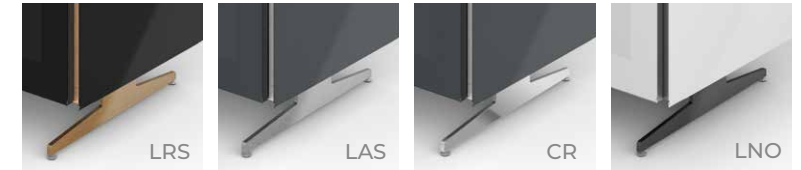

## MO&MA TV-ELEMENTE

### MO&MA GROUNDSTYLE

4 Grundbreiten - Breiten 125 / 150 / 175 / 200cm  
 2 Grundhöhen - Höhen 42 und 51cm / 1 Grundtiefe - Tiefe 50cm  
 Abdeckplatten in Glas, Echtholz und Keramik in den jeweiligen Grundbreiten

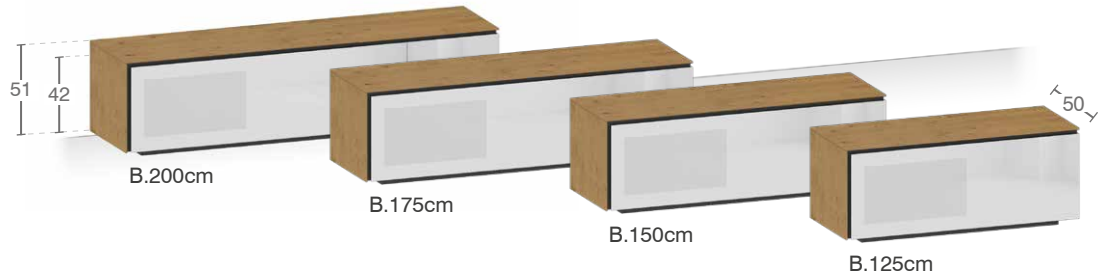

## MO&MA TV-HÄNGEELEMENTE

### MO&MA WALLSTYLE

3 Grundbreiten Breiten 150 / 175 / 200cm  
 1 Grundhöhe Höhe 37cm / 1 Grundtiefe - Tiefe 37cm  
 Abdeckplatten in Glas, Echtholz und Keramik in den jeweiligen Grundbreiten



Versteckte Rollen in Sockelplatte für einfaches Kabelmanagement und optimale Reinigung hinter dem Möbel

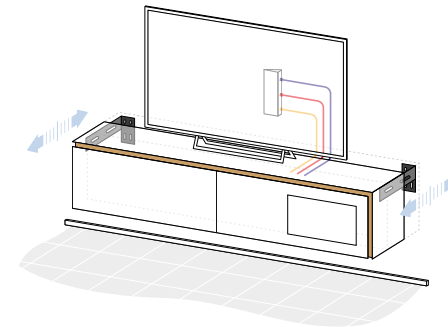

Neuartiger Hängebeschlag für optimale Rückwandbelüftung und einfaches und flexibles Kabelmanagement.



## MO&MA TV-ELEMENTE



TV-Element MMB 202 NE-NE-LRS li.

Breite 200cm



TV-Element MMB 150 GS-GS-LAS re. Breite 150cm

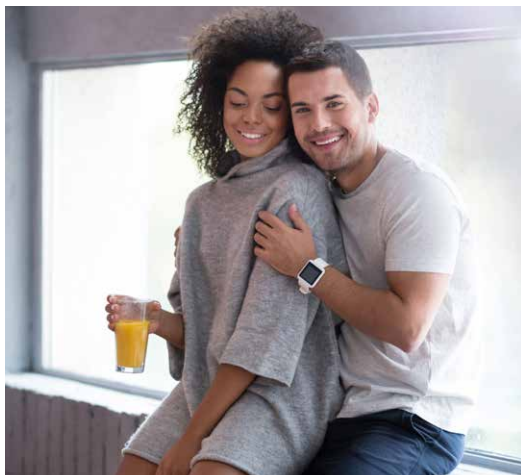

## GROUNDSTYLE



TV-Element MMB 202 BI-RG-LNO li. + MOF 200 LNO

Breite 200cm

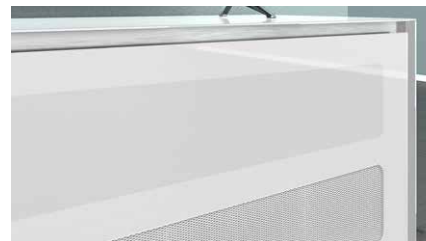

SOUNDSYSTEM ACS 120 W  
B.95 H.18 T.30



TV-Element MMB 175 BI-CCE-LAS re.

Breite 175cm

## MO&MA TV-ELEMENTE



TV-Hängeelement MMW 150 BI-RA-LAS li. Breite 150cm



MMW 176 GS-RN-LNO re. + Hängeelemente Breite 230cm



TV-Hängeelement MMW 200 NE-NE-LRS li. + Hängeelemente Breite 250cm



## WALLSTYLE



TV-Hängeelement MMW 200 BI-CCE-LNO re. + Hängeelemente

Breite 235cm



TV-Hängeelement MMW 200 GS-RG-LAS li. + Hängeelemente

Breite 235cm

## MO&MA LIVING



Sideboard MMS 220 GS-RN-LNO li.

Breite 220cm

## FREESTYLE



Couchtisch MMT 120 BI-RG-LNO

Breite 122cm



Sideboard MMS 220 NE-NE-LRS li.

Breite 220cm



Sideboard MMSW 200 BI-RA-LAS re.

Breite 200cm



Couchtisch VR 081 BI

Breite 81cm



# KOLLEKTION RAVENNA

Design by Eros Angelini

## Puristisches Highlight in Glas

Das TV-Möbelprogramm Ravenna besticht durch eine klare Linienführung und sorgt für ein besonderes Wohnerlebnis.

Zwei Höhen, sechs Farben, acht Versionen und der Charme von lackiertem Glas machen dieses Programm zu einem Designmöbel für Smart People. Dieser moderne und minimalistische Stil passt sich allen Wohnbereichen an, von Young Fashion bis zum elitären Wohnen.

Das besondere Designmerkmal ist der pulverbeschichtete Metallgriff in anthrazit der sich in der in Linienführung der Infrarotabsetzung bei der Glasfront wiederfindet.



ONE STYLE  
MANY  
SOLUTIONS



# RAVENNA KOLLEKTION IM DETAIL



TV-Element RV 150 BIO

Breite 150cm

Extras, die je nach Modell bereits in den Möbeln enthalten sind:



Temperiertes Glas

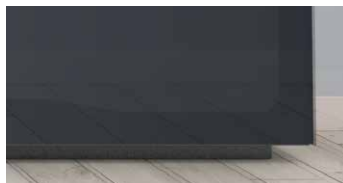

Infrarotdurchlässige Glasfront



Pulverbeschichteter Metallgriff



Hochwertige Beschläge



Glas-Einlegeböden



Rollen in Sockelplatte oder Designfuß

# RAVENNA TV-ELEMENTE

3 lieferbare Breiten

## GROUNDSTYLE



RV 126 BAS B.125 - H.49,5 - T.45



RV 150 BAS B.150 - H.37,5 - T.45



RV 152 BAS B.150 - H.49,5 - T.45



RV 176 BAS B.175 - H.49,5 - T.45

## FOOTSTYLE

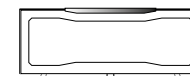

RV 126 F/P B.125 - H.58,5 - T.45

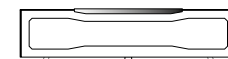

RV 150 F/P B.150 - H.46,5 - T.45

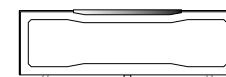

RV 152 F/P B.150 - H.58,5 - T.45



RV 176 F/P B.175 - H.58,5 - T.45

## GLAS-AUSFÜHRUNGEN



...NE Glas schwarz glänzend



...BI Glas weiß glänzend



...GR Glas grau glänzend



...GS Glas dunkelgrau glänzend



...NEO Atzglas schwarz matt



...BIO Atzglas weiß matt

## RAVENNA GROUNDSTYLE



TV-Element RV 176 BIO

Breite 175cm



TV-Element RV 152 NE

Breite 150cm

## RAVENNA FOOTSTYLE



TV-Element mit Designfuß RV 176 GR - F

Breite 175cm



TV-Element mit Designfuß RV 150 GS - F

Breite 150cm





arreda l'elettronica

**MUNARI S.r.l.**

37050 Ca' degli Oppi di Oppeano (Verona) Italy

Ph. +39 045 7130145/190

[www.munari.it](http://www.munari.it)

e-mail: [munari@munari.it](mailto:munari@munari.it)

